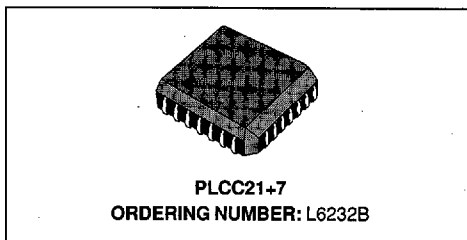

SPINDLE DRIVER
ADVANCE DATA

- 1.5A MAXIMUM PEAK CURRENT
- CONTROLLED SLEW RATE
- CENTRAL CHARGE PUMP
- PWM AND LINEAR MODES
- CUTOFF TIME USER CONFIGURABLE
- FAST, FREE-WHEELING DIODES ON CHIP
- OVER-TEMPERATURE PROTECTION
- BRAKE FUNCTION INPUT

DESCRIPTION

The L6232A is a triple half bridge driver intended for use in brushless DC motor applications. This part can be used to form the power stage of a three-phase, brushless DC motor control loop, and is especially useful for disk drive applications. Power drivers are Integrated DMOS transistors and feature fast recirculating diodes as an integral

part of their structure. The logic inputs are TTL-level compatible, with internal pull-up, allowing interfacing to open collector outputs. All necessary circuitry to perform PWM and linear motor speed control is included. A central charge pump is utilized to drive the upper DMOS transistors, and also to power the braking function. The L6232B is packaged in PLCC28.

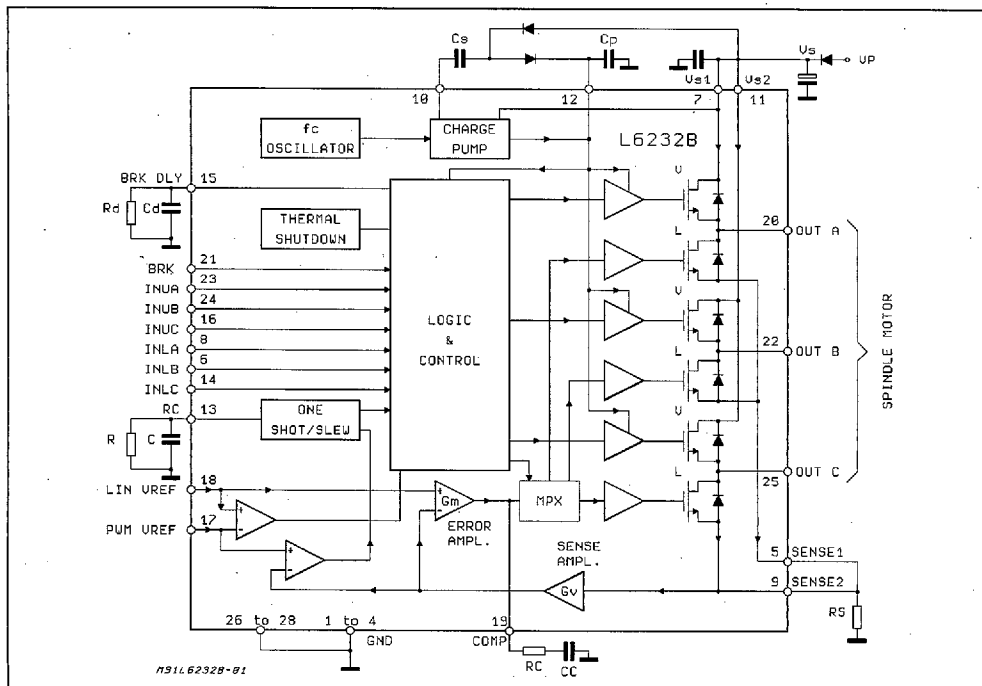
BLOCK DIAGRAM

PIN DESCRIPTION

Pin	Name	Function
1 to 4	GND	Common Ground. Also provides heat-sink to PCB.
5, 9	SENSE	Output for current sense resistors.
6	INLB	Logic Input to turn on the lower driver (Active High).
7, 11	V _s	Supply Voltage.
8	INLA	Logic input to turn on the lowey driver (Active High).
10	C _s	External Charge Pump Capacitor.
12	C _P	External Main Charge Pump capacitor.
13	RC	Cutoff Time RC Network in PWM mode. The Resistor value is also used to define the slew-rate in linear mode (LIN).
14	INLC	Logic input to turn on the lower driver (Active High).
15	BRK DLY	External RC network for the brake delay.
16	INUC	Logic Input to turn on the upper driver (Active Low).
17	PWM Vref	Input for Reference Control in PWM mode
18	LIN Vref	Input for Reference Control voltage in LIN mode
19	COMP	External compensation for error amplifier
20	OUTA	DMOS Half-bridge A Out.
21	BRK	Active LOW logic input that triggers the delayed brake.
22	OUTB	DMOS Half-bridge B Out.
23	INUA	Logic Input to turn on the upper drivers (Active Low).
24	INUB	Logic Input to turn on the upper drivers (Active Low).
25	OUTC	DMOS Half-bridge C Out.
26 to 28	GND	Common Ground. Also provides heat-sink to PCB.

PIN CONNECTION (Top view)

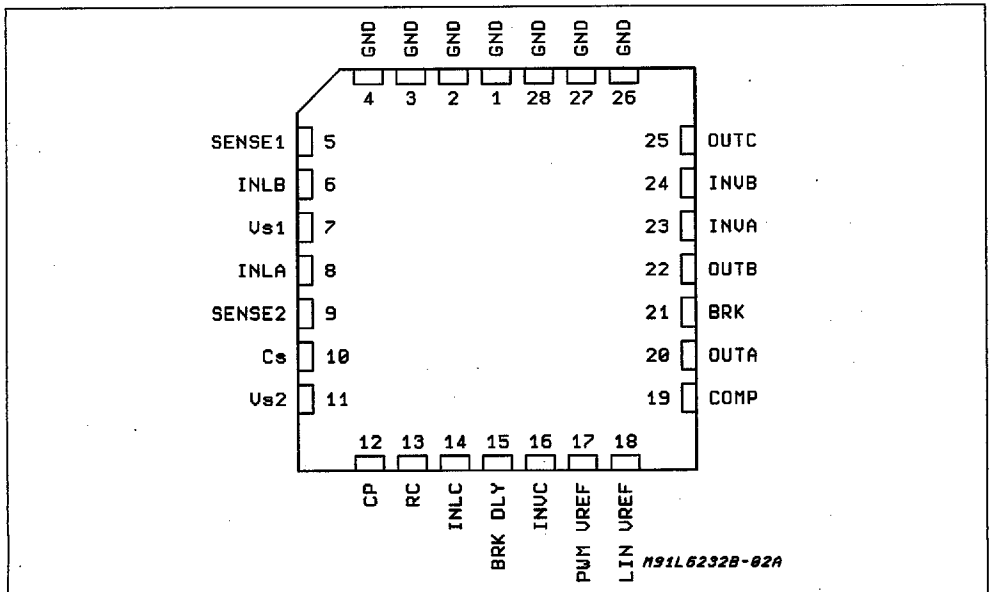

ABSOLUTE MAXIMUM RATINGS

Symbol	Parameter	Value	Unit
$V_{DS\text{ sus}}$	Peak Output Sustaining Voltage	15	V
V_S	Supply Voltage	15	V
$V_{O\text{ peak}}$	Output Peak Voltage ($t_{PK} = 5\ \mu\text{sec}$; 10% d.c.)	18	V
V_{CP}	Charge Pump Input Voltage	30	V
V_i	Logic Input Voltage	-0.3 to 7	V
V_{REF}	PWM VREF--LIN VREF Input Voltage	-0.3 to 7	V
V_{IS}	Sense Input Voltage	-1 to 7	V
I_D	Sink-Source Peak Output Current (*)	3.5	A
I_O	Sink-Source DC Output Current	1.8	A
P_{tot}	Total Power Dissipation ($T_{amb} = 70\text{C}$)	1.5	W
T_{stg}, T_j	Storage and Junction Temperature	-40 to 150	C

THERMAL DATA

Symbol	Description	Value	Unit
$R_{th\ j-pin}$	Thermal Resistance Junction-pins	Max. 14	$^{\circ}\text{C/W}$
$R_{th\ j-amb}$	Thermal Resistance Junction-ambient (**)	Max. 52	$^{\circ}\text{C/W}$

Notes

(*) Pulse width (limited only by junction temperature and by the transient thermal resistance.

(**) Mounted on board with 16cm^2 $35\mu\text{m}$ thickness copper area on board heatsink.

ELECTRICAL CHARACTERISTICS (See the block diagram, $V_S = 12\text{V}$, $R = 100\text{k}\Omega$; $C = 180\text{pF}$; $T_j = 25\text{C}$, unless otherwise specified)

Symbol	Parameter	Test Condition	Min.	Typ.	Max.	Unit
V_S	Supply Voltage		10.5	12	13.5	V
I_S	Quiescent Supply Current	BRK = L; INUA = INUB = INUC = L; INLA = INLB = INLC = H; Table 1		0.3	0.5	mA
		BRK = H; INUA = INUB = INUC = H; INLA = INLB = INLC = L; Table 1		4	6	mA
I_{OL}	Output Leakage Current	$V_O = V_S = 13.5\text{V}$			1	mA
R_{DSon}	Sink Out ON Resistance	$T_j = 25\text{C}$ (see Fig.4)		0.42	0.47	Ω
		$T_j = 125\text{C}$		0.7		Ω
R_{DSon}	Source Out ON Resistance	$T_j = 25\text{C}$ (see Fig.4)		0.42	0.47	Ω
		$T_j = 125\text{C}$		0.7		Ω
V_F	Body Diode Forward Drop (sink and source)	$I_{DS} = 1\text{A}$ (see Fig. 6)		1	1.5	V
$t_d(\text{BRK})$	Brake Delay Time	See Fig. 1, 3; note 1		210		ms
T_{BRK}	Braking Time		10			s
$I_{B(\text{LIN})}$	LIN Vref Input Bias Current	LIN $V_{ref} = 0.4$ to 5.5V		400	800	nA
$I_{B(\text{PWM})}$	PWM Vref Input Bias Current	PWM $V_{ref} = 0.4$ to 5.5V		400	800	nA
LIN V_{ref}	Reference Voltage Input	Note 2; $R_S = 0.5\Omega$ $I_{motor}(\text{PWM}) = 1\text{A}$ $I_{motor}(\text{LIN}) = 200\text{mA}$		2		V
PWM V_{ref}				0.4		V
G_v	Sense Amplifier Voltage Gain	PWM $V_{ref} = 2.5\text{V}$, LIN $V_{ref} = 0.4\text{V}$, $R_S = 0.5\Omega$; Note 2	3.8	4	4.2	V/V

ELECTRICAL CHARACTERISTICS (continued)

Symbol	Parameter	Test Condition	Min.	Typ.	Max.	Unit
G_m	LIN Error Amplifier Transconductance			0.8		mAV
Z_{out}	Error Amplifier Output Impedance			2		M Ω
V_{INH}	Logic Input Voltage BRK; INUA; INUB; INUC; INLA; INLB; INLC		2			V
V_{INL}					0.8	V
$I_{INH(Leak)}$	Logic Input Current BRK; INUA; INUB; INUC; INLA; INLB; INLC	$V_i = 2.7V$			-1	mA
I_{INL}		$V_i = 0.4V$			-0.1	mA
t_{donU}	Upper/Lower Turn-on Delay	Table 1 see Fig. 3		0.7		μs
t_{donL}				0.15		μs
t_{doffU}	Upper/Lower Turn-off Delay			15		μs
t_{doffL}				0.5		μs
dV/dt	Source DMOS Slew-Rate (PWM)	see Fig. 3	10			V/ μs
dV/dt	Source DMOS Slew-Rate (LIN)	see Fig. 3			1	V/ μs
dV/dt	Sink DMOS Output Turn-off Slew-Rate	Note 3; R = 100K Ω		0.1		V/ μs
F_C	Internal Clock Frequency			380		KHz
T_{off}	PWM Cutoff Time	R=100K Ω ; C=180pF, Note 4; see Fig. 2		12		μs
T_{sd}	Shutdown Temperature			160		C
T_{sdr}	Recovery Temperature			120		C

Notes:

- 1) The Head Park time must be shorter than the Brake Delay time $t_{off(BRK)} = R_d C_d$
- 2) Both in PWM and in LIN mode the Ref. Voltage must agree to $V_{ref} = G_v R_s I_{motor}$
- 3) The resistance of the RC network defines the dV/dt value.
- 4) $t_{off} = 1.8RC + 6 \cdot 10^6$

Table 1

INPUT STATE						OUTPUT STATE		
INUA	INUB	INUC	INLA	INLB	INLC	A	B	C
L	L	L	H	H	H	*	*	*
L	L	L	L	L	L	H	H	H
H	H	H	L	L	L	*	*	*
H	H	H	H	H	H	L	L	L

H = The Upper DMOS is ON

L = The Lower DMOS is ON

* = Tristate condition

Figure 1: Brake Delay and Braking timing of the L6232B. At the time t1 a VP Powerdown threshold detector drives low the BRK input; at time t2 the Charge Pump voltage becomes inadequate to maintain ON the lower DMOS.

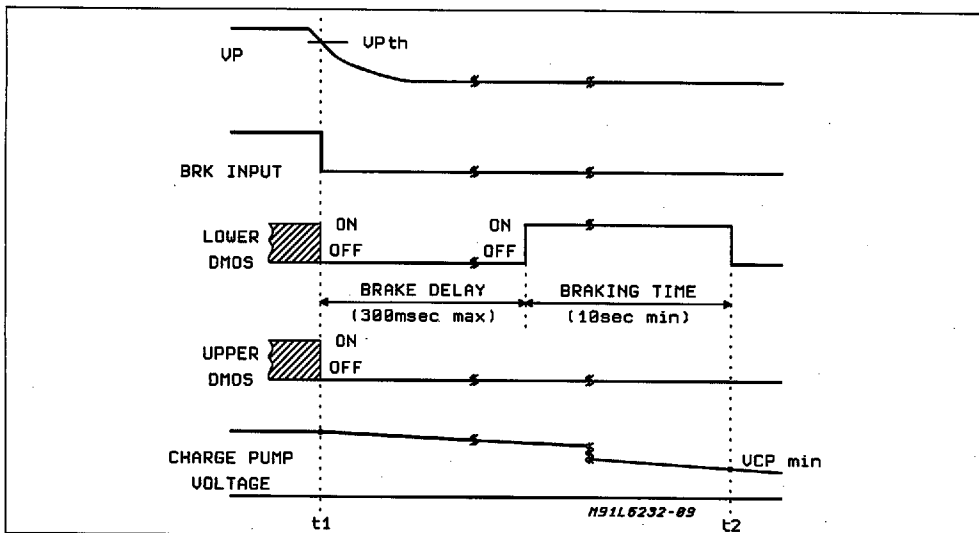

FUNCTIONAL DESCRIPTION (Refer to the Block Diagram)

The commutation sequence is provided by the user via six inputs. INUA, INUB, INUC turn on the three upper DMOS drivers when held at logic LOW, and inputs INLA, INLB, INLC turn on the three lower DMOS drivers when held at logic HIGH.

The BRK and BRK DLY inputs offer flexibility to the system designer in the implementation of the braking function. The BRK logic input, when pulled low will turn-off all upper and lower Dmos drivers. The low transition at BRK will produce a delayed negative transition at the BRK DLY input, configurable by connection of a capacitor Cd and a resistor Rd from the BRK DLY pin to ground. The negative transition at BRK DLY will initiate the braking of the motor by turning on all lower Dmos, while keeping all upper DMOS turned-off. This feature provides a time interval where the motor BEMF can be used to power the head parking function before the braking procedure is initiated. External detection of the supply (VP) drop-off is necessary to provide the appropriate logic signal to the BRK input. (see Fig. 1)

The brake function utilizes the energy stored in the central charge pump capacitor (Cp) to turn-on or turn-off the DMOS drivers. This allows for completion of the braking procedure after the VP supply has powered down.

The L6232B is capable of driving the motor in either pulse width modulation (PWM) or linear

(LIN) mode. The driving mode is determined by the smaller of two analog voltages inputs, LIN Vref and PWM Vref. The motor current is controlled by LIN Vref and PWM Vref and the current sense resistor Rs connected to the SENSE output. The SENSE output provides for connection of a resistor in series with the source of all lower DMOS drivers. The voltage at this pin provides the error signal which is utilized internally to regulate the motor current Im. The current in both PWM and linear mode is determined by the expression :

$$I_m = \frac{V_{ref}}{G_v \cdot R_s}$$

in which Gv is the voltage gain of the sense amplifier. In linear mode, the current is regulated by a linear control loop which drives the lower DMOS. Compensation of the linear control loop is achieved by connection of a series network (Rc, Cc) from the transconductance amplifier output (Gm) and ground. Control is passed to each lower DMOS in succession during the commutation sequence (MPX).

The rate at which the upper and lower drivers turns-off during linear mode operation is configurable externally by the value of the resistor R used at the RC pin. This defines a current which is utilized internally to limit the voltage slew-rate at the outputs during transitions. The output slew-rate is internally adjusted for fast slewing during PWM operation to reduce losses, and a relatively

slower rate during linear mode operation to minimize noise effects (EMI). LIN Vref and PWM Vref are connected to a comparator whose output is fed to the logic. The upper and lower DMOS driver slew-rates are controlled by the internal logic.

In PWM mode, the upper driver is turned-off when the motor current reaches the intended value. An internal One-Shot pulse determines the length of time the upper driver stays off before turning on again. The pulse width, and thus the cutoff time (toff), is configurable by means of the external RC network connected to the RC pin. (see Fig. 2). The resistor at the RC pin, therefore determines both the driver output slew-rate during linear mode and the off-time constant during PWM. The lower driver is always on during PWM mode of operation; an on-chip 2μs mask can prevent the beginning of a new cutoff time because of transient current spikes caused by the upper drivers turn-on.

The driving mode is determined by the smaller of the two controlling input voltages. In a typical application the motor start-up would occur in PWM mode to limit power dissipation, with on-speed control then performed in linear mode.

Thermal protection circuitry will shut-off all drivers when the chip junction temperature exceeds the threshold temperature. A small amount of hysteresis is included to prevent rapid on/off cycling of the power stages.

Additional protection is provided against driver input combinations where the upper and lower drivers of a half bridge are turned on simultaneously, resulting in a short from supply to ground. The chip logic will cause both the upper and lower drivers involved to turn-off. (see Table 1)

APPLICATION INFORMATION

A typical application configuration of the L6232B driving a three-phase brushless DC motor is shown in Fig.3. The spindle motor is a 4 ohm-2mH per phase, star connected. This load requires a suitable compensation of the linear control loop that can be achieved by $R_c = 10 \text{ Kohm}$ and $C_c = 10\text{nF}$ (R3;C8). Changing the motor characteristics, the RcCc network would be modified for the best performances of the system. At the start-up of the spindle is driven in PWM mode fixed toff time.

The off-time is calculated by the formula :

$$t_{off} = 0.69 R_2 C_7$$

See fig.2 for a quick choice of the needed capacitor, after the resistor has been fixed. The value of the resistor defines the rate at which the upper and lower drivers turn-off during linear mode operation to avoid EMI effects. During turn-off, the slew rate is constant for the sink stage, while it has a varying slope for the source stage because of the non linear change of the gate to source im-

Figure 2: Typical toff vs. Capacity of C

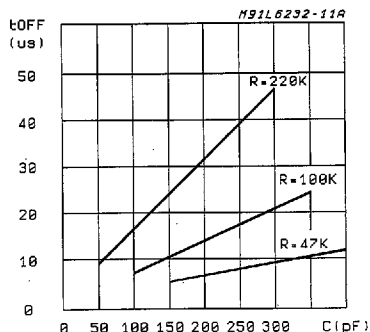

pedance of the DMOS transistor. Practically, the slowest slew rate is obtained at the sink transistor switch-off time (see fig. 5), then it increases during the first period of the source transistor switch-off (source, 1st) and it becomes the fastest during the final portion of the turn-off duration (source, 2nd). The PWM to linear mode of operation is switched by decreasing the LIN Vref level under the PWM Vref value that could be fixed and calculated by:

$$\text{PWM Vref} = 4 R_s I_p$$

where I_p is the peak chopping current in the motor windings. Of course, when the required RPM is reached, it become of no need a strong torque and the LIN Vref starting from a value higher than the calculated PWM Vref, decreases to the value :

$$\text{LIN Vref} = 4 R_s I_m$$

where I_m , smaller than I_p , is the needed motor current to keep constant spin. This last reference voltage is generally a PLL output driven by speed transducers coupled to the spindle (like Hall effect sensors or BEMF processors). To drive the upper DMOS and during the brake function a voltage higher than the supply V_s is needed. The charge pump integrated in the L6232B keeps C3 at the correct voltage. To guarantee efficient braking of the motor, C3 must be chosen of adequate quality (very high equivalent parallel resistance). C4 can be a ceramic disk capacitor. The typical application of the L6232B is in HDD systems on which there is the need to park the Read-Write Heads before the motor braking. This behavior is possible with the circuit of Fig.3. At Power Supply switch-off (see Fig. 1), V_P falls down and drives down the BRK input (Active Low). D1 insulates the L6232B from the power supply output while the power output stage is switched in a high impedance state. The spindle motor acting as a three-phase alternator supplies the Heads voice coil motor driven through integrated diodes that rectify the EMF. After a delay longer than the parking time, the lower output DMOS are switched-on and the spindle motor is braked. The brake delay time is typically 150

msec and it is defined by :

$$td(BRK) = 1.4 R1 C6$$

The sensing resistor value is generally lower than 1ohm, but a wire wounded type must be avoided. In Fig.3 the 0.33 ohm sensing resistor

itors. Care must be taken in the PC Board design particularly about ground loops and ground copper area. The typical Thermal Resistance junction to ambient versus PC Board copper area (Fig.7) is shown in Fig 8. For Transient Thermal Resistance see Fig. 9.

Figure 3: Typical Application Circuit

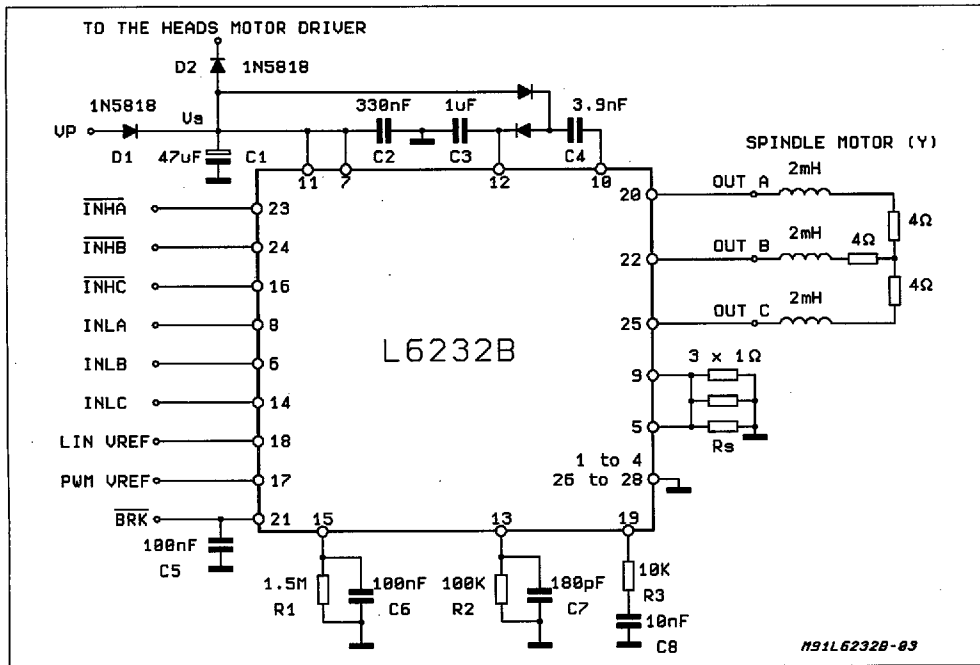

is shown as three parallel 10hm metal film resis-

Figure 4: Typical Normalized $R_{DS(on)}$ vs. Junction Temperature

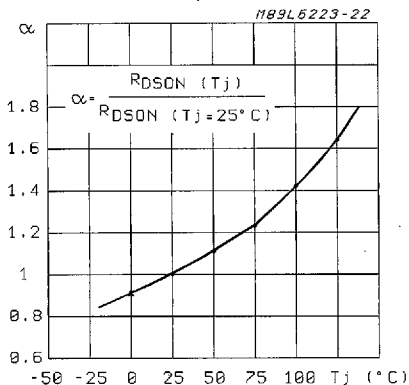

Figure 5: Output Voltage Slew Rate Control vs. $1/R_2$ Value

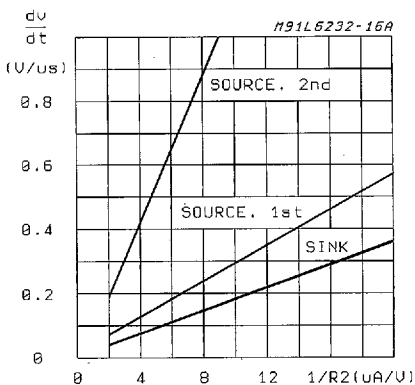

Figure 6: Typical Body Diode Forward Drop vs. Drain to Source Current.

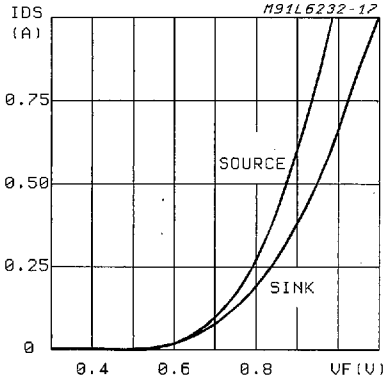

Figure 7: On Board Dissipation Copper Area Size

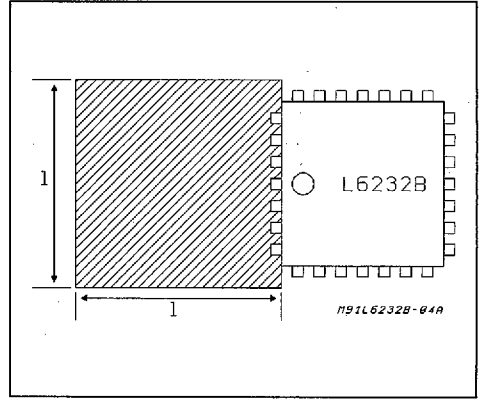

Figure 8: Typical $R_{th\ j-amb}$ vs. On-Board Heatsink Side I.

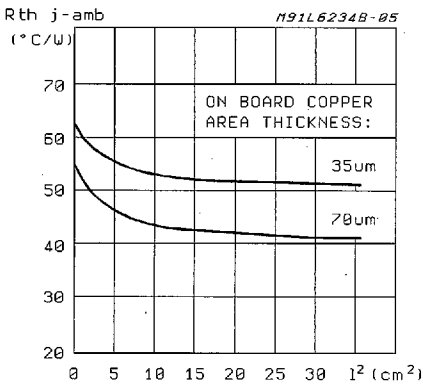

Figure 9: Typical Transient R_{th} in Single Pulse Condition.

